

# MRS MACHINE PUMP-BACK STATIONS

## THE FLEXIBLE ALTERNATIVE FOR CHIP- AND COOLANT HANDLING



## CHIPS AND COOLANT EASY CONVEYING...



**MRS-D**

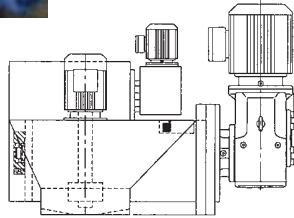

**MRS-BP**

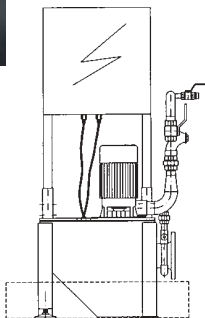

**MRS-RC**

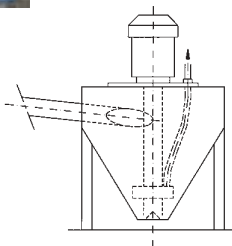

Machine pump back stations are easy to retrofit nearly to all types of machines. Chips and coolant (oil as well as emulsion) will be conveyed through pipes to a central filter or processing plant.



*Central filter processing plant pumped by MRS pump back stations*

Because of the flexible constructional style you can also connect single machines with a MRS. For example: to reclaim expensive oils.

For bushy type of chips the MRS can be extended with a crusher for pumping chips and coolant.

# ...REDUCE COOLANT COSTS



... the alternative to costly in-floor constructions

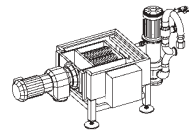
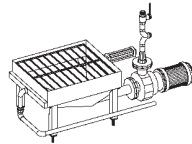
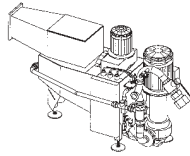

**mayfran**

amount of types

		Tank Dimensions mm			Type of operation	Capacity* l/min	
		Height	Width	Length		Oil	Emulsion
MRS-D	with drag conveyor	up 400	from	variable	machine tools	40 - 1100	40 - 1100
MRS-RC	without conveyor		400	400 - 1000	grinding	45 - 600	90 - 1200
MRS-BP	without conveyor		to	400 - 1000	grinding	45 - 600	90 - 1200
MRS-S	with spiral conveyor		1000	variable	machine tools	35 - 780	70 - 1560
MRS-Special	Custom required construction				all types of operation	depends on requirements	

All MRS-Types can be upgraded with a crusher or power screen classifier

\* Capacities depend on type of coolant as well as type and quantity of chips



## ADVANTAGES OF MRS PUMP BACK STATIONS:

- Easy change from single filter units to central coolant cleaning and supply
- No more expensive costly in-floor constructions
- Money saving because of low investment costs
- Flexibility of MRS is also guaranteed after relocation of machine tools
- Clean hall floors because of closed piping systems
- MRS can be individually designed for new machine tools

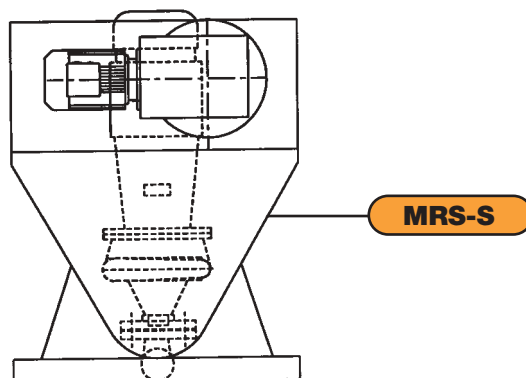

Examples for MRS-Special

## Mayfran International B.V.

P.B. 31032, Edisonstraat 7  
NL-6370 AA Landgraaf/The Netherlands

Tel.: 31-45-5329292  
Fax: 31-45-5329300  
E-mail: [info@mayfran-europe.com](mailto:info@mayfran-europe.com)



### Mayfran U.K. Ltd., Orchard Court V

Binley Business Park, Harry Weston Road, Coventry CV3 2TQ  
Tel.: 01203-459000, Fax: 01203-459690

### Mayfran France S.A.R.L.

Centre D'Affaires, Paris-Nord, Immeuble le Bonaparte  
F-93153 Le Blanc Mesnil Cedex/France  
Tel.: 33-1-48-65-7800  
Fax.: 33-1-48-67-7629

### Mayfran GmbH, Roermonder Str. 594

D-52072 Aachen/Germany  
Tel.: 49-241-938720, Fax: 49-241-175080  
E-mail: [sales@mayfran-europe.com](mailto:sales@mayfran-europe.com)

### Mayfran International (Inc.)

P.O. Box 43038  
Cleveland, OH 44143 /U.S.A.  
Tel.: 1-440-461-4100  
Fax: 1-440-461-5565  
E-mail: [info@mayfran.com](mailto:info@mayfran.com)

### Tsubakimoto Mayfran Inc.

5001 Ohno, Tsuchiyama-Cho, Kouga-Gun  
Shiga 528-02/Japan  
Tel.: 81-7486-7-1001  
Fax: 81-7486-7-1097

### Mayfran Canada Ltd.

5955 Airport Road, Suite 300  
Mississauga, Ontario, Canada L4V 1R9  
Tel.: 1-905-678-0018  
Fax: 1-905-678-0019

### Miven Mayfran

P.O. Box 59 Karwar Road,  
Hubli-580 024/India  
Tel.: 91-836-303-677  
Fax: 91-836-303-265

### Korea Mayfran

72-1, Onsoo-dong  
Kuro-ku 152-120, Seoul/Korea  
Tel.: 82-2-611-5886  
Fax: 82-2-686-2521